



SERIE MO



MO 11



MO 12



MO 13



MO 14



MO 15



MO 16



MO 17



MO 18

Note tecnica
 Technical remarks
 Remarques techniques
 Technische Bemerkungen

106_107

108_109

- MO 11
- MO 12
- MO 13
- MO 14
- MO 15
- MO 16
- MO 17
- MO 18



MO 19



MO 20



MO 21



MO 22



MO 23



MO 24



MO 25



MO 26

110_111

- MO 19
- MO 20
- MO 21
- MO 22
- MO 23
- MO 24
- MO 25
- MO 26

SERIE MO

1	2	3
Corpo Body Corps Körper	Dado Nut Écrou Überwurfmutter	Ogiva Olive Bague Schneidring
Ottone UNI EN 12164 CW614N - UNI EN 12165 CW617N Nichelato Brass UNI EN 12164 CW614N - UNI EN 12165 CW617N Nickel Plated Laiton UNI EN 12164 CW614N - UNI EN 12165 CW617N Nickelé Messing UNI EN 12164 CW614N - UNI EN 12165 CW617N vernickelt	Ottone UNI EN 12164 CW614N Nichelato Brass UNI EN 12164 CW614N Nickel Plated Laiton UNI EN 12164 CW614N Nickelé Messing UNI EN 12164 CW614N vernickelt	Ottone UNI EN 12164 CW614N Brass UNI EN 12164 CW614N Laiton UNI EN 12164 CW614N Messing UNI EN 12164 CW614N

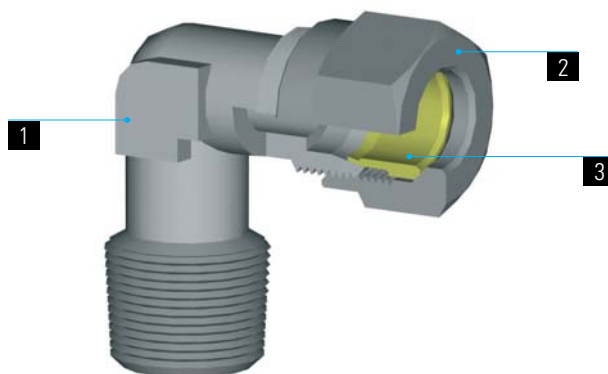

RACCORDI SERIE MO

I raccordi della serie MO garantiscono l'aggraffaggio del tubo e la tenuta del raccordo tramite la compressione sul tubo di un anello denominato "ogiva". Le sedi delle ogive, le ogive ed i dadi componenti questa serie, sono dimensionati seguendo le prescrizioni delle norme DIN che regolamentano questa tipologia di prodotto; in particolare per l'ogiva e sede ogiva DIN 3861, mentre per il dado DIN 3870. I raccordi di questa serie prevedono un trattamento superficiale di Nichelatura.

THE MO LINE

The MO fitting gripping and tightness system on the tubing is performed by the olive compression on the tube. The MO fittings are manufactured according to the following DIN norms:

- the Olive and Olive seat: DIN 3861
- Nuts: DIN 3870

Our MO fittings are brass nickel-plated

LA SERIE MO

La tenue et l'étanchéité sur le tube de nos raccords MO est garantie par la compression de la bague sur le tube. Ils sont construits selon les normes DIN, soit:

- Pour la bague et son siège: DIN 3861
- Pour l'écrou: DIN 3870

Tous nos raccords MO sont en laiton niquelé

DIE MO SERIE

Die Schlauchdichtheit wird bei der MO Serie durch die Schneidringkompression am Schlauch erlangt. Unsere MO Verschraubungen werden nach den DIN Normen hergestellt und zwar:

- Beim Schneidring und dessen Gehäuse: DIN 3861
- Bei der Überwurfmutter: DIN 3870

Unsere MO Verschraubungen sind aus Messing vernickelt.

SPECIFICHE TECNICHE

Tubi di collegamento consigliati:
Tubi in Rame, Alluminio e con l'impiego dell'apposito rinforzo interno (MO 23) sono utilizzabili tubi in PA11 e PA6.

Tolleranze accettabili sui tubi:
+/- 0,07 mm fino a Ø 10 mm
+/- 0,1 mm fino a Ø 15 mm.

Temperatura di esercizio:
-20°C÷70°C

Pressione di esercizio:
max 60 bar

Campi di applicazione:
Impianti pneumatici, idraulici ed oleodinamici.

DATA SHEET

Recommended tubings:
Copper and aluminium tubings. PA11 and PA6 tubings are to be used with our MO 23 reinforcement part.

Acceptable Tolerances on the tubings:
+/- 0,07 mm up to Ø 10 mm
+/- 0,1 mm up to Ø 15 mm

Working Temperature:
-20°C÷70°C

Working Pressure:
max 60 bar

Application fields:
Pneumatic, hydraulic and oleodynamic circuits.

REINSEIGNEMENTS TECHNIQUES

Tubes conseillés:
Tubes Cuivre et Aluminium. Le PA11 et PA6 seulement avec pièce de renforcement MO 23.

Tolerances sur les tubes:
+/- 0,07 mm jusqu'au Ø 10 mm
+/- 0,1 mm jusqu'au Ø 15 mm.

Températures de service:
-20°C÷70°C

Pression de service:
max 60 bar

Domaines d'application:
Circuits pneumatiques, hydrauliques et oléodynamiques.

TECHNISCHE AUSKÜNFTE

Empfohlene Schläuche:
Kupfer und Aluminiumschläuche. PA11 und PA6 sollten aber mit dem Verstärkungshülse, MO 23 eingesetzt werden.

Schlauchtoleranzen:
+/- 0,07 mm bis Ø 10 mm
+/- 0,1 mm bis Ø 15 mm.

Temperaturbereich:
-20°C÷70°C

Druckbereich:
max 60 bar

Anwendungsbereiche:
Hydraulische, öldynamische und pneumatische Anlagen.

Profondità di inserimento del tubo

Tubing insertion depth

Profondeur d'insertion du tube

Schlaucheinstecktiefe

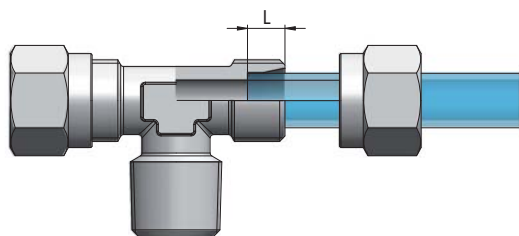

Øe Tubo	L
4	4
5	5,5
6	5,5
8	5,5
10	7
12	7
15	7

1. Tagliare il tubo a 90° verificando l'assenza su questo di bave interne ed esterne;
2. Inserire il dado e l'ogiva sul tubo avendo l'accortezza di orientare l'ogiva con il tagliante verso l'estremità del tubo da collegare al raccordo;
3. Avvitare manualmente il dado fino ad avvertire una certa resistenza all'avvitamento;
4. Dopo aver verificato il corretto posizionamento del tubo, servendosi di una chiave, serrare il dado avvitandolo di circa 1 1/2 - 2 giri in base al tipo di raccordo;
5. Al solo scopo di verifica, svitare il dado e controllare che l'ogiva abbia fatto presa in modo uniforme sul tubo;
6. Riavvitare il dado forzandolo di 1/4 di giro per assicurare la tenuta del sistema.

Avvertenza: nel caso occorra collegare al raccordo tubi curvi, assicurarsi che la curvatura del tubo sia ad una distanza almeno pari al doppio dell'altezza del dado.

1. Cut the tube square and make sure that no burr (internally and externally) is left;
2. Insert the tube through the nut and olive. The olive edge is to be placed towards the tube ending;
3. Finger tighten the nut until resistance;
4. Check the tube is well positioned, and tighten the nut with a spanner 1 1/2 - 2 more turns according to the fitting used;
5. Just for safety, screw-off the nut and check that the olive is evenly gripping on the tubing;
6. Screw-on the nut a further 1/4 of a turn to grant the system tightness.

Remark: Should curved tubings, need to be connected, pls make sure that the tube curving be at least at twice the nut height distance.

1. Couper le tube à 90° tout en vérifiant que aucune bavure intérieure ou extérieure se forme;
2. Monter l'écrou et la bague sur le tube en faisant attention que la bordure tranchante de la bague soit bien vers la fin du tube;
3. Visser à la main l'écrou jusqu'à on s'aperçoit d'une certaine résistance au vissage;
4. Après avoir vérifié que le tube est bien positionné, visser l'écrou (si nécessaire par une clé) 1 1/2 - 2 tours selon la taille du raccord;
5. Afin de vérifier, dévisser l'écrou et contrôler que la bague ait agrafé le tube uniformément;
6. Visser encore l'écrou 1/4 de tour pour assurer la tenue du système.

Remarque: Dans le cas où il faut brancher des tubes courbés, veuillez contrôler que la distance de la courbure du tube au raccord soit min. deux fois l'hauteur de l'écrou.

1. Schlauch bei 90° abschneiden und feststellen, dass es danach keinen Innen-oder-Aussengrät übrigbleibt;
2. Überwurfmutter und Schneidring auf den Schlauch montieren, und darauf achten, dass die Schneidringkanten sich am Ende des zur Montage notwendigen Schlauches befindet;
3. Die Überwurfmutter von Hand auf das Gewinde aufschrauben;
4. Nach Überprüfung, dass der Schlauch in guter Stellung ist, wenn notwendig, die Überwurfmutter mit einem Schlüssel für 1 1/2 - 2 Umdrehungen festschrauben;
5. Nur zur Überprüfung, die Überwurfmutter lösen und feststellen, dass der Schneidring gleichförmig den Schlauch verklammert;
6. Zur Sicherstellung der Systemsdichtheit, die Überwurfmutter um eine weitere 1/4 Umdrehung festziehen.

Bemerkung: Beim Einsatz von gebogenen Schläuchen, bitte darauf achten, dass der Schlauchbogen von der Verschraubung zweimal der Überwurfmutterhöhe weit ist.

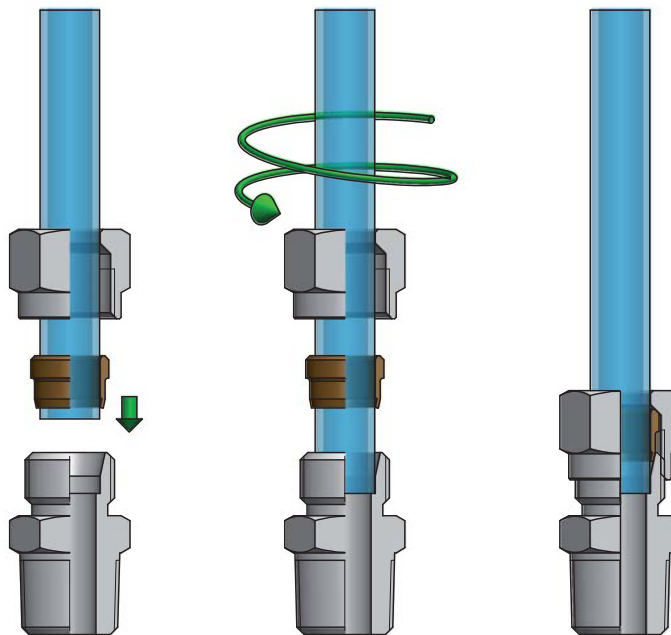

Effettuato il collegamento, assicurarsi che il tubo inserito nel raccordo non sia sottoposto ad alcuna forza di trazione; è necessario inoltre rispettare durante il collegamento del tubo il raggio minimo di curvatura consigliato così come riportato nella sezione tubi di questo catalogo tecnico (vedi pag.92) Per il serraggio delle parti filettate del raccordo si raccomanda di attenersi alle coppie consigliate riportate a pag.6



Once the tubing is connected to the fitting, make sure that the tubing is not subject to any tensile strength and that the min. recommended bending radius stated in the tubing section of this catalogue is complied with (see page 92). To tighten threads, please check our tightening torque chart illustrated at page 6.



Une fois effectué le branchement, s'assurer que le tube inséré dans le raccord n'est soumis à aucune force de traction. Egalement, il est nécessaire de respecter, lors du branchement du tube, le rayon minimum de courbure conseillé dans la section tubes de ce catalogue technique (voir la page 92). Pour le serrage des parties filettées du raccordo, il est recommandé de s'en tenir aux couples de serrage conseillés et reportés à la page 6.



Nach der Schlauchverbindung, sicherstellen, dass der in die Verschraubung eingeführte Schlauch keinen Zugbelastungen ausgesetzt ist; beim Anschluss des Schlauchs muss der empfohlene Mindestbiegeradius eingehalten werden, gemäß den in diesem technischen Katalog im Schlauchabschnitt, angegebenen Hinweisen (siehe Seite 92). Zum Festziehen der Gewinde sich an den, auf Seite 6 empfohlenen Drehmomente einhalten.

MO 11

Diritto Maschio Conico

Taper Straight, male

Union Simple mâle conique

Gerade Einschraubverschraubung, kegelig

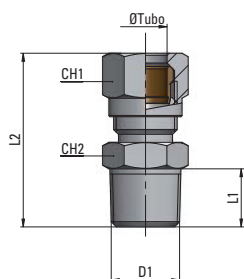

Tipo	Øe Tubo	D1	L1	L2	CH1	CH2	g Δ
11 04 18	4	R1/8	8	27	10	10	12
11 05 18	5	R1/8	8	28	12	11	16,5
11 06 18	6	R1/8	8	28	12	12	16
11 06 14	6	R1/4	11	32,5	12	14	26
11 08 18	8	R1/8	8	29,5	14	12	19
11 08 14	8	R1/4	11	33	14	14	24
11 08 38	8	R3/8	11,5	33	14	17	40
11 10 14	10	R1/4	11	37,5	19	17	46
11 10 38	10	R3/8	11,5	38	19	17	56
11 12 38	12	R3/8	11,5	39	22	19	60
11 12 12	12	R1/2	14	41	22	22	83
11 15 12	15	R1/2	14	42,5	27	22	104

MO 12

Diritto Maschio Cilindrico

Parallel Straight, male

Union simple male cylindrique

Gerade Einschraubverschraubung, zylindrisch

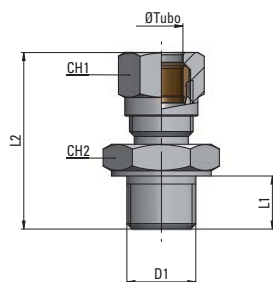

Tipo	Øe Tubo	D1	L1	L2	CH1	CH2	g Δ
12 04 M5	4	M5x0,8	5	26	10	9	9
12 04 18	4	G1/8	6	25	10	14	17
12 05 18	5	G1/8	8	29	12	14	20
12 06 18	6	G1/8	6	26	12	14	18
12 06 14	6	G1/4	8	29,5	12	17	24,5
12 08 18	8	G1/8	6	27,5	14	14	22
12 08 14	8	G1/4	8	30	14	17	33
12 10 14	10	G1/4	8	34,5	19	17	50
12 10 38	10	G3/8	9	36	19	19	62
12 12 38	12	G3/8	10	39	22	22	68
12 12 12	12	G1/2	12	42	22	27	98
12 15 12	15	G1/2	12	43	27	27	118

MO 13

Diritto Femmina

Female Straight

Union Simple femelle

Gerade Aufschraubverschraubung

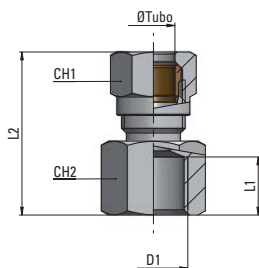

Tipo	Øe Tubo	D1	L1	L2	CH1	CH2	g Δ
13 04 18	4	G1/8	8	24,5	10	14	18
13 05 18	5	G1/8	10	29	12	14	22
13 06 18	6	G1/8	8	26	12	14	22
13 06 14	6	G1/4	11	30,5	12	17	35
13 08 18	8	G1/8	8	26,5	14	14	24
13 08 14	8	G1/4	11	31	14	17	38
13 10 14	10	G1/4	11	35,5	19	17	56
13 10 38	10	G3/8	11,5	36,5	19	20	66

MO 14

Giunzione Intermedia

Union

Union simple égale

Gerade Verbindung

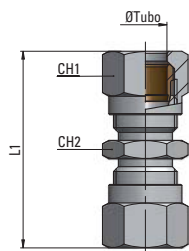

Tipo	Øe Tubo	L1	CH1	CH2	g Δ
14 04 04	4	33,5	10	10	12
14 05 05	5	36	12	11	23
14 06 06	6	36,5	12	12	21
14 08 08	8	38,5	14	14	28
14 10 10	10	47,5	19	17	70
14 12 12	12	50,5	22	19	89
14 15 15	15	55,5	27	24	148

MO 15

Giunzione Intermedia passaparte

Bulkhead union

Union traversée de cloison

Gerade Schottverschraubung

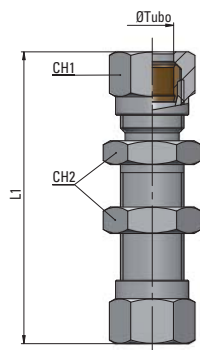

Tipo	Øe Tubo	L1	CH1	CH2	g
15 04 04	4	57	10	12	27
15 05 05	5	60	12	14	41
15 06 06	6	51,5	12	14	39
15 08 08	8	55,5	14	16	55
15 10 10	10	62,5	19	19	104
15 12 12	12	64,5	22	22	136
15 15 15	15	69,5	27	25	183

MO 16

Gomito maschio conico

Taper Elbow Fitting, male

Raccord à coude mâle conique

Winkelverschraubung, kegelig

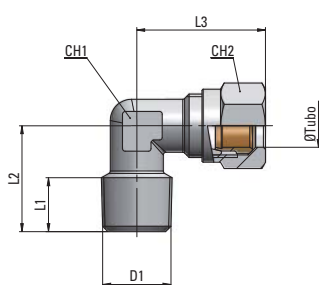

Tipo	Øe Tubo	D1	L1	L2	L3	CH1	CH2	g
16 04 18	4	R1/8	8	16	21	9	10	15
16 05 18	5	R1/8	8	17	23	9	12	17,5
16 06 18	6	R1/8	8	16	22	9	12	16
16 06 14	6	R1/4	11	20	24,5	11	12	20
16 08 18	8	R1/8	8	17	24	11	14	22
16 08 14	8	R1/4	11	20	24	11	14	25,5
16 10 14	10	R1/4	11	23,5	32	13	19	52
16 10 38	10	R3/8	11,5	24	32	13	19	52
16 12 38	12	R3/8	11,5	25,5	34,5	15	22	67
16 12 12	12	R1/2	14	28,5	34,5	15	22	78
16 15 12	15	R1/2	14	30	38	17	27	102

MO 17

Gomito Intermedio

Union Elbow

Raccord à Coude

Winkelverschraubung

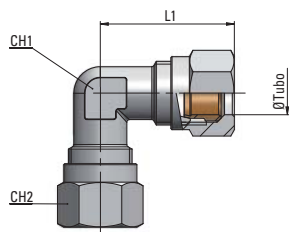

Tipo	Øe Tubo	L1	CH1	CH2	g
17 04 04	4	21	9	10	19
17 05 05	5	23	9	12	22
17 06 06	6	23	9	12	22
17 08 08	8	24	11	14	32
17 10 10	10	32	13	19	76
17 12 12	12	34,5	15	22	98
17 15 15	15	38	17	27	145

MO 18

T Intermedio

Union Tee

T égal

T-Verschraubung

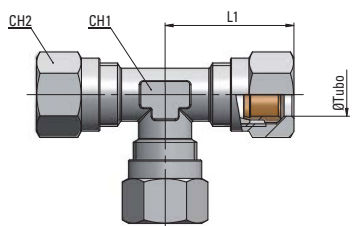

Tipo	Øe Tubo	L1	CH1	CH2	g
18 04 04	4	21	9	10	21
18 05 05	5	23	9	12	36
18 06 06	6	23	9	12	34
18 08 08	8	24	11	14	42
18 10 10	10	32	13	19	112
18 12 12	12	34,5	15	22	144
18 15 15	15	38	17	27	212

MO 19

T centrale conico

Taper Male Tee

T mâle, central

T-Einschraubverschraubung

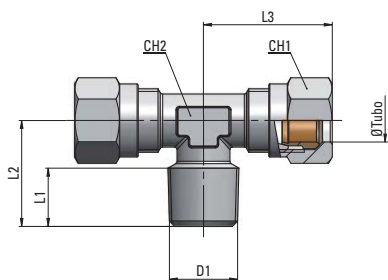

Tipo	Øe Tubo	D1	L1	L2	L3	CH1	CH2	g Δ
19 04 18	4	R1/8	8	16	21	9	10	22
19 05 18	5	R1/8	8	17	23	9	12	28
19 06 18	6	R1/8	8	16	23	9	12	28
19 06 14	6	R1/4	11	20	24	11	12	29
19 08 18	8	R1/8	8	17	24	11	14	38
19 08 14	8	R1/4	11	20	24	11	14	40
19 10 14	10	R1/4	11	23,5	32	13	19	87
19 10 38	10	R3/8	11,5	24	32	13	19	92
19 12 38	12	R3/8	11,5	25,5	34,5	15	22	118
19 12 12	12	R1/2	14	28,5	34,5	15	22	128
19 15 12	15	R1/2	14	30	38	17	27	168

MO 20

T laterale conico

Taper Lateral Tee

T mâle, latéral

L-Einschraubverschraubung

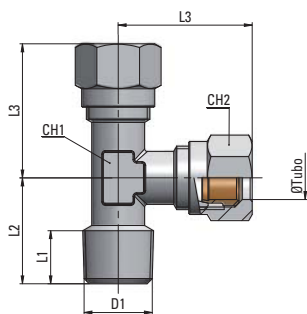

Tipo	Øe Tubo	D1	L1	L2	L3	CH1	CH2	g Δ
20 04 18	4	R1/8	8	16	21	9	10	23
20 05 18	5	R1/8	8	17	23	9	12	30
20 06 18	6	R1/8	8	16	23	9	12	27
20 06 14	6	R1/4	11	20	24,5	11	12	29
20 08 18	8	R1/8	8	17	24	11	14	38
20 08 14	8	R1/4	11	20	24	11	14	42
20 10 14	10	R1/4	11	23,5	32	13	19	88
20 10 38	10	R3/8	11,5	24	32	13	19	94
20 12 38	12	R3/8	11,5	25,5	34,5	15	22	122
20 12 12	12	R1/2	14	28,5	34,5	15	22	132
20 15 12	15	R1/2	14	30	38	17	27	180

MO 21

Dado

Nut

Écrou

Überwurfmutter

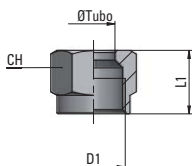

Tipo	Øe Tubo	D1	L1	CH	g Δ
21 04 08	4	M8x1	11	10	4
21 05 10	5	M10x1	11,5	12	6
21 06 10	6	M10x1	11,5	12	6
21 08 12	8	M12x1	12	14	7
21 10 16	10	M16x1,5	15,5	19	19
21 12 18	12	M18x1,5	15,5	22	26
21 15 22	15	M22x1,5	17	27	43

MO 22

Ogiva

Olive

Bague

Schneidring



Tipo	Øe Tubo	L1	g Δ
22 04 65	4	6	0,5
22 05 75	5	7,5	1
22 06 75	6	7	2
22 08 75	8	7	2
22 10 95	10	10	2
22 12 95	12	10	3
22 15 10	15	10	3

MO 23

Anima di rinforzo

Inner reinforcement piece for tubings

Pièce Renfortage intérieur pour tubes

Innere Verstärkungsstück für Schläuche

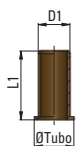

Tipo	Øe Tubo	D1	L1	g
23 06 12	6	4	12	1
23 08 14	8	6	13	1
23 10 16	10	8	14	2
23 12 18	12	10	16	3
23 15 20	15	12,5	17	4

MO 24

Attacco con filetto cilindrico

Stem adaptor

Branchement avec filetage cylindrique

Anschluß mit zylindrischem Gewinde

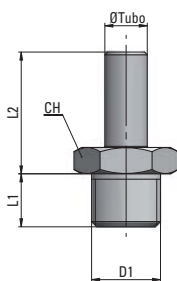

Tipo	Øe Tubo	D1	L1	L2	CH	g
24 04 18	4	G1/8	8	19	14	8
24 05 18	5	G1/8	8	22	14	12
24 06 18	6	G1/8	8	22	14	10
24 06 14	6	G1/4	10	22	17	16
24 08 18	8	G1/8	8	23	14	12
24 08 14	8	G1/4	10	23	17	17
24 10 14	10	G1/4	10	27	17	20
24 10 38	10	G3/8	10	27	22	32
24 12 38	12	G3/8	10	27	22	32
24 12 12	12	G1/2	12	27	27	56

Disponibile fino esaurimento scorte - Available until sold out

Verfügbare bis Lagerverbrauch - Disponible jusqu'à épuisement stock

MO 25

Anello singolo

Single Banjo Ring

Banjo simple

Ringstück

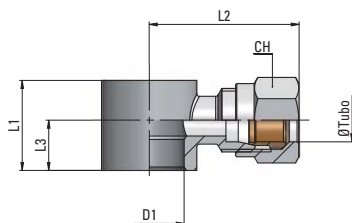

Tipo	Øe Tubo	D1	L1	L2	L3	CH	g
25 06 18	6	10	15	26	9	12	19
25 06 14	6	13,2	17	28	9,5	12	26
25 08 18	8	10	15	27	9	14	21
25 08 14	8	13,2	17	29	9,5	14	28

MO 26

Adattatore

Adaptor

Adaptateur

Adapter

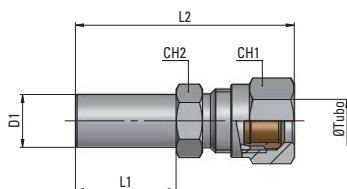

Tipo	Øe Tubo	D1	L1	L2	CH1	CH2	g
26 08 06	6	8	18	38	12	12	15
26 10 06	6	10	19	39	12	12	16
26 10 08	8	10	19	41	14	12	20
26 12 08	8	12	19	41	14	14	22

Disponibile fino esaurimento scorte - Available until sold out

Verfügbare bis Lagerverbrauch - Disponible jusqu'à épuisement stock